

**N4000, N5000, N6000,  
N4000TS, N5000CS,  
N6000NBP  
ABS Handle Hand Cups**

**Guide to Maintenance,  
Troubleshooting, and Repair**



## General Maintenance

For maximum reliability, **INSPECT THE HAND CUP REGULARLY**: Make sure the air filter is in place; if not, discontinue use until the filter is replaced. Examine the plunger and handle for cracks or other damage. Examine the face of the vacuum pad for excessive glaze (a polished, glossy appearance) and for cuts or roughness on the sealing edges. Periodically test the cup for excessive leakage, sluggishness in plunger action or radical changes in the number of strokes needed to keep the red line hidden. If the cup does not function normally, review the Troubleshooting Guide (overleaf) to determine what corrective action is needed.

To **CLEAN THE VACUUM PAD**, remove the air filter from the pad face. Use a clean sponge or lint-free cloth to apply Wood's Powr-Grip® Vacuum Cup Cleaner to the pad face. Soapy water or other mild cleansers may also be used. **Never use solvents or rubber conditioners as a cleaning agent** (see WARNINGS). To prevent liquid from contaminating the pump during cleaning, hold the cup face-down or cover the suction inlet in the filter recess. For 8" [204 mm] pads, be careful not to dampen the felt strip at the pad's edge. Wipe all residue from the pad face and allow the cup to dry. Then reinstall the air filter.

## Inspecting and Testing the Cup for Leakage

To **INSPECT THE SEALING EDGES** of the vacuum pad for roughness or foreign material, slowly draw your finger along the entire length of the sealing edges. Examine the sealing edges for cuts by bending the edge of the pad face towards you to create a hump, turning the hand cup as necessary. If cuts or cracks are present in a sealing edge, a V-shaped gap will appear. Any pad that exhibits a gap or excessive roughness in a sealing edge must be replaced.

To **LEAK-TEST THE HAND CUP**, attach it to a clean, smooth, scratch-free piece of glass or metal for approximately 2 hours. The red line on the plunger serves as a vacuum indicator: If the red line *does not* appear during the test period, the cup is usable; if the red line *does* appear, perform general maintenance and repeat the test. If the problem persists, check the Troubleshooting Guide (overleaf) to identify possible causes and appropriate corrective actions. If these measures do not restore the cup to normal performance, contact the Wood's Powr-Grip Customer Service department or an authorized dealer for assistance.



## PARTS AND ASSEMBLY

1	90151	Handle / Release Valve Assembly
2	90154	Plunger Assembly
3	49486T	Vacuum Pad, 8" [204 mm] Dia., Flat (G0695)
	49488T	Vacuum Pad, 8" [204 mm] Dia., Textured Surface (G0695TS)
	49506T	Vacuum Pad, 9" [229 mm] Dia., Flat (G0725)
	49520T	Vacuum Pad, 9" [229 mm] Dia., Concave (VPCS9)
	49586T	Vacuum Pad, 10" [254 mm] Dia., Concave (G0750)
4	61151	Check Valve Retainer
5	51100	Check Valve
6	60024	Air Filter
7	10002	Handle Screws (6)

	Not Shown	
29330	8" [204 mm] Case	
29338	9" [229 mm] Case	
29342	10" [254 mm] Case	
28675	Wood's Powr-Grip® Vacuum Cup Cleaner	
28504	Silicone Lubricant	

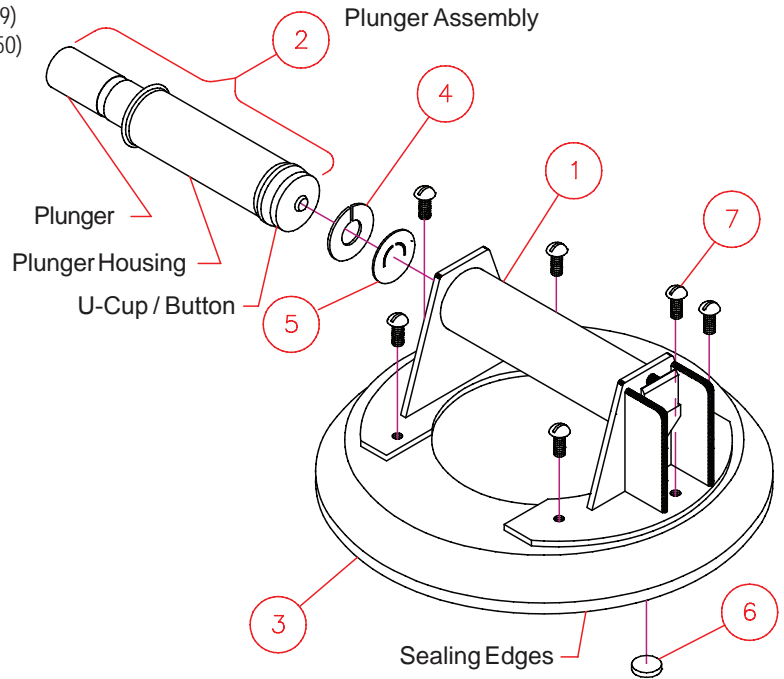

## TROUBLESHOOTING GUIDE

PROBLEM	CAUSE	CORRECTION
Slow leakage	Cuts on sealing edge	Replace vacuum pad.
	Dirt or lint inside pump	Wipe inside of handle with a soft cloth. Check for contamination on U-cup or button.
	Dry pump	Apply a light coating of silicone lubricant inside handle.
	Scratches inside handle (between mid-point and closed end)	Replace handle.
	Release valve pad contamination	Open release valve and blow valve pad clean with air hose.
Severe leakage	Gouges or cuts on sealing edge	Replace vacuum pad.
	Broken handle or release valve	Replace handle / release valve assembly.
Jammed or sluggish pump	Dry pump	Apply a light coating of silicone lubricant inside handle.
	Obstructed valve stem	<b>Remove obstruction (through suction inlet behind air filter).</b>
	Severe contamination	Clean plunger assembly and inside of handle.
Pad slips when attached	Contaminated load surface	Wipe surface clean. If necessary, wash and allow to dry.
	Contaminated pad face	Clean vacuum pad.
More than 10 strokes needed to apply	Any of the above	Perform general maintenance.
	Dirt or lubricant on check valve	Remove, clean and reinstall plunger assembly, retainer and check valve as directed in Disassembly and Assembly sections (on facing page).

## Disassembly Procedures

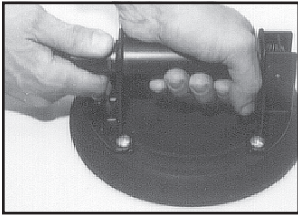

### Remove Plunger Assembly from Handle

Grasp the head of the plunger assembly and pull it straight out from the handle. Be careful to keep the plunger assembly clean and free from contaminants. It is advisable to cover the plunger assembly with a clean, lint-free towel when it is not in the handle.

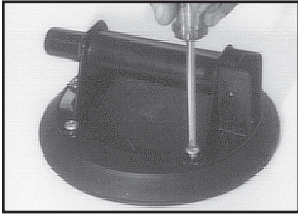

### Remove Handle from Vacuum Pad

Remove the 6 handle screws, and separate the handle from the pad. Carefully remove the valve stem from the rubber nipple on the pad by gently pulling on the handle and twisting it back and forth.

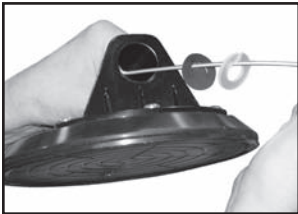

### Remove Retainer and Check Valve from Handle

Being careful not to scratch the inside of the handle, remove the retainer and check valve using a hooked scribe or similar tool. With a soft, lint-free cloth, carefully clean these parts, as well as the plunger assembly, paying particular attention to the U-cup and button. Wrap a small dowel or rod with a soft, lint-free cloth and gently wipe the inside of the handle, to make sure it is clean and dry (lubricant-free).

## Assembly Procedures

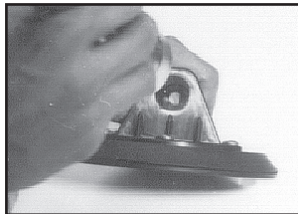

### Inspect Handle and Reinstall Check Valve and Retainer

Carefully examine the inside of the handle for scratches and contaminants, using a flashlight for illumination. Scratches between the mid-point and the closed end of the handle can cause leakage. Scratches near the open end of the handle rarely present a problem. Make sure that no lubricant remains inside the handle. Drop the check valve inside the handle so that it lays flat against the closed end. Using a dowel or other tool that will not scratch the sides of the handle, push the retainer all the way into the handle to hold the check valve securely in place.

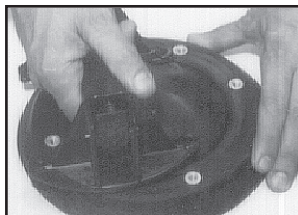

### Attach Handle to Vacuum Pad

Apply a light coating of silicone lubricant to the valve stem of the handle, and insert the valve stem into the pad nipple. Place the handle on the pad so its nipple fits through the large hole in the base plate near the closed end of the handle. Align the screw holes and reinstall the handle screws.



### Reinsert Plunger Assembly into Handle

Apply lubricant all the way around the exposed surface of the U-cup, while being careful to keep lubricant off the button. Silicone lubricant is recommended and available in appropriate quantities by contacting Wood's Powr-Grip Customer Service. ***Do not use improper lubricants in the handle.***

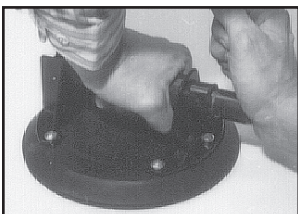

While making certain the button, check valve and retainer remain free of lubricant, insert the U-cup end of the plunger assembly into the handle. Push the plunger assembly until it begins to tighten; then seat the plunger assembly with one strong, swift motion. Operate the plunger to spread the lubricant, thoroughly coating the outside of the U-cup by twisting the plunger as it moves. Now the cup is assembled and ready for testing.

# WARNINGS

Wood's Powr-Grip has taken great care to produce the most reliable vacuum-operated handling device available. Nevertheless, mistreatment or misuse may damage a hand cup or otherwise create conditions which could cause the hand cup to fail, resulting in an unexpected release. The following warnings are offered to help users avoid most potential hazards.

**Failure to observe WARNINGS could damage the cup or the load, or cause injury to the user.**

- Do not use the cup with loads that exceed the load capacity.
- Do not use the cup to support a person.
- Do not place the pad face against surfaces which could damage the sealing edges.
- Avoid conditions that could cause the cup to slip or to disengage prematurely, such as: contaminants, cuts or scratches in the pad face or load surface; applying the cup to porous materials; or applying pressure against the pad edge.
- Do not use the cup to lift when the red line is visible. If the red line reappears frequently, discontinue use and follow the instructions for general maintenance and testing.
- Do not allow anything to interfere with free movement of the plunger while the cup is attached. This could prevent the red line from warning the user of vacuum loss.
- Do not touch the valve release lever while lifting.
- Do not attach 10" [254 mm] diameter cups (models N6000 and N6000NBP) to thin, fragile materials.
- Do not use harsh chemicals (such as solvents or gasoline) or unauthorized rubber cleaners and conditioners to clean the cup. See [www.powrgrip.com](http://www.powrgrip.com) for more information.